



产 品 承 认 书

PRODUCT SPECIFICATION

产品型号 (Product Number): **BM566智能软件板-集成北斗GPS定位**
BM566 Intelligent Software Board - Integrated Beidou-GPS

客户名称 (Customer Name):

客户型号(Customer Model):

配置 Configuration	参数 Parameter	配置 Configuration	参数 Parameter
串数 Number of battery strings	6~16S	RS485接口 RS485 interface	5PIN, 450mm排线 5PIN, 450mm cable
适用电池 Applicable battery	三元锂、磷酸铁锂 NMC, LFP	CAN接口 CAN interface	支持, 与RS485同接口 Support, same as RS485 interface
持续放电电流 Continuous discharge current	150A、200A	采样排线 Sampling cable	6+12P, 1000mm
芯片方案 Chip solution	中颖集成方案 Zhongying solution	蓝牙通信 BT communication	支持 Support
北斗GPS定位 Beidou GPS positioning	有 Support	放电开关 Discharge switch	支持 Support
均衡 Equalization	自动均衡, 电阻放电方式 Automatic equalization, resistive discharge mode	预加热功能 Preheating function	外挂, 最大支持15A充电加热 Add-on, support up to 15A charging and heating
电流积分 Coulometer	支持3000A以内检测 Support detection within 3000A	预放电功能 Pre-discharge Function	支持, 防打火, 可选配 【带显示仪表不支持此功能】 Support, anti-spark, optional (Instrument with display does not support this function)
显示屏 Display screen	支持, RS485屏 Support, RS485 screen	电池温度检测 Battery temperature detection	4路NTC 4-channel NTC

后续描述与配置表有矛盾的以上面配置表为准

If there is any conflict between the following description and the configuration table, refer to the preceding configuration table.

编 制 PREPARED BY	审 核 CHECKED BY	批 准 APPROVED BY



客户确认栏

CUSTOMER APPROVED

确认意见 Confirmation Comments:

客户签章 Approval Signature:

日期 Date:

深圳市明唐新能源技术有限公司

Shenzhen Mingtang New Energy Technology Co., Ltd.

地 址：深圳市南山区粤海街道麻岭社区深南大道9988号大族科技中心1501室

Address: Room 1501, Han's Laser Technology Center, 9988 Shennan Avenue, Maling Community, Yuehai Street, Nanshan District, Shenzhen

T E L : 400-0568266

注：客户收到样品以及规格书后，请及时回复，如在7天之内无回复，我司将视客户已承认此规格书中的参数以及送样样品。规格书中的图片为通用机型的图片，可能与送样样品有一定的差异；经贵公司确认生效，此规格书仅限我司及贵公司内部使用，未经我司许可不得给予第三方，且我司拥有对此规格书的最终解释权。

Notice : Please respond promptly upon receiving the samples and specification. If no reply is received within 7 days, we will consider that the customer has approved the parameters and sample provided.

The images in the specification are for general models and may differ from the samples sent; this specification, upon confirmation, is for internal use only between our company and yours and should not be disclosed to third parties without our permission. We reserve the final interpretation right for this specification.



目 录 Content

一、综述 Overview	4
二、产品功能特性 Product Functional Characteristics	4
三、电气参数 Electrical Parameters (Ta = 25 °C.)	6
3.1、额定规格参数 Rated Specifications	6
3.2、基本功能参数 Basic Functional Parameters	8
3.3、GPS规格参数 GPS Specifications	13
3.4、低功耗及唤醒 Low Power and Wake-up	13
3.5、显示屏功能 Display Function	14
四、通信说明 Communication Description	14
4.1、LTE通信 LTE Communication	14
4.2、RS485通信 RS485 Communication	14
4.3、CAN通信 CAN Communication	14
五、BMS保护板尺寸图 BMS Protection Board Dimensions	15
六、参考图及安装说明 Reference Diagram and Installation Instructions	16
6.1、保护板元件视图 Protection Board Component View	16
6.2、电池采样线接线定义 Battery Sampling Line Wiring Definition	19
6.3、RS485&CAN通信接口说明 ——【可选配功能】	23
Description of RS485 and CAN Communication Interface - (Optional Features)	23
6.4、温度采集接口说明 Temperature Acquisition Interface Description	24
6.5、安装连接说明 Installation and Connection Instructions	25
6.6、保护板激活开机说明 Protection Board Activation and Power-on Instructions	26
七、天线把手安装说明 Antenna Handle Installation Instructions	27
7.1、天线把手实物及尺寸图：Antenna Handle and Its Dimension Drawing	27
7.2、天线把手安装要求 Antenna Handle Installation Requirements:	28
7.3、温度传感器安装注意事项 Temperature Sensor Installation Precautions	31
八、使用注意事项 Usage Precautions	33
九、主要元器件清单 Main Component List	36
十、产品修订记录表 Product Revision Record	36



一、综述 Overview

本规格书适用于深圳市明唐新能源技术有限公司的锂电池保护板，本产品严格满足ROHS标准。

This specification applies to the lithium battery protection board of Shenzhen Mingtang New Energy Technology Co., Ltd.. This product strictly meets the ROHS standards.

随着锂电池的广泛应用，对电池管理系统提出了高性能、高可靠性及高性价比等要求。BMS电池系统俗称为电池管家，BMS实时采集、处理、存储电池组运行过程中的重要信息，与外部设备如整车控制器交换信息，解决锂电池系统中安全性、可用性、易用性、使用寿命等关键问题。主要作用是为了能够提高电池的利用率，防止电池出现过充电和过放电，延长电池的使用寿命，监控电池的实时状态。

With the widespread application of lithium batteries, high performance, high reliability, and high cost-effectiveness are required for battery management systems. The BMS battery system is commonly known as the battery steward. The BMS collects, processes, and stores important information during the operation of the battery pack in real-time, exchanges information with external devices such as vehicle controllers, and solves key issues of safety, availability, ease of use, and service life in lithium battery systems. Its main purpose is to improve battery utilization, prevent overcharging and over-discharging, extend battery life, and monitor the battery's real-time status.

本BMS保护板，采用集成化的设计，将采集、管理、通信等功能集成于一体，可进行高精度的GPS定位【兼容北斗和GPS】，保证动力电池安全可靠、高效及长寿命的运行。

This BMS protection board adopts an integrated design, integrating functions such as collection, management, and communication, supporting high-precision GPS positioning (compatible with Beidou and GPS), ensuring safe, reliable, efficient, and long-lasting operation of power batteries.

二、产品功能特性 Product Functional Characteristics

- 具有单体电压、总体电压检测，过充、过放报警及保护功能。

Equipped with monomer voltage, total voltage detection function, overcharge, over-discharge alarm, and protection function.

- 具有充电、放电过流报警及保护功能。

Equipped with charging and discharging over-current alarm and protection function

- 具有电芯、MOS 温度实时检测功能；电芯高、低温报警及保护功能；MOS 高温报警及保护功能。

Equipped with real-time detection of cell and MOS temperature; high and low temperature alarm and protection function for cells; high temperature alarm protection function for MOS.

- 具有对输出短路的检测及保护功能。

Equipped with output short circuit detection and protection function.

- 具有自动均衡功能，可以在充电时对不均衡的电芯进行均衡。

Equipped with automatic balancing function can balance unbalanced cells during charging.

- 软件远程控制功能，可通过平台软件方便地对电池的相关参数进行设置。

Software remote control function, convenient setting of relevant battery parameters through platform software.

- **RS485 通信，采用隔离通信方式。**

RS485 communication, using an isolated communication mode.



- **电流积分功能【库仑计】。**
Current integration function (coulomb meter).
- **SOC 计量：采用电流积分与开路电压算法相结合。**
SOC measurement: using a combination of current integration and open circuit voltage algorithm.
- **支持单体电压掉线检测、单体电压检测、总电压检测。**
Support monomer voltage disconnection detection, monomer voltage detection, and total voltage detection.
- **实时定位；电池异常提醒；低电提醒；震动防盗报警；电子围栏；轨迹回放；里程统计；空中升级；远程控制充电、放电功能；实时监测电池电压、电池电量SOC、充放电循环次数；实时监测电池温度、BMS保护板温度，实现双重保护功能。**
Real-time positioning; battery abnormal reminder; low power reminder; vibration anti-theft alarm; electronic fence; track playback; mileage statistics; over-the-air upgrade; remote control charging and discharging function; real-time monitoring of battery voltage, battery capacity SOC, charging and discharging cycles; real-time monitoring of battery temperature, BMS protection board temperature, realizing dual protection function.
- **具有多种休眠及唤醒方式。**
Multiple sleep and wake-up methods.
- **具有预放电功能，防打火【可选配】**
Pre-discharge function, anti-spark. (optional)
- **支持固件OTA远程升级**
Firmware can be upgraded over-the-air (OTA).



三、电气参数 Electrical Parameters (Ta = 25 °C.)

3.1、额定规格参数 Rated Specifications

详细项目 Detailed Items		规格 Specification			单位 Units	其它说明 Other Description
		最小值 Minimum	典型值 Typical	最大值 Maximum		
放电电流 Discharge current		-	/	-	A	150A、200A可选 150A, 200A optional
充电电流 Charging current		-	/	-	A	150A、200A可选 150A, 200A optional
工作电流【模块工作】 Working current [module operation]		-	20	25	mA	保护板工作状态 Protection board in working status
待机电流【模块休眠】 Standby current [module sleep]		-	10	15	mA	保护板待机状态 Protection board in standby status
低功耗模式电流【关机】 Low power mode current [shutdown]		-	10	20	μA	保护板关机状态 Protection board in shutdown state
工作环境 Working environment	工作温度 Working temperature	-20	-	+70	°C	正常工作温度范围 Normal working temperature range
	工作湿度 Working humidity	0%	-	90%	RH	湿度低于90%，无凝结 Humidity below 90%, no condensation
存储环境 Storage environment	存储温度 Storage temperature	-40	-	+85	°C	正常存储温度范围 Normal storage temperature range
	存储湿度 Storage humidity	0%	-	90%	RH	湿度低于90%，无凝结 Humidity below 90%, no condensation
电流积分 Coulometer	SOC估算精度 SOC accuracy	<5%				
	电流检测 Current detection	采样频率<250mS, 精度5% Sampling frequency <250mS, accuracy 5%				
RS485接口 RS485 interface		支持1路 Support 1 channel				



CAN接口 CAN interface	支持1路 Support 1 channel	保护板默认匹配120Ω电阻 The protection board matches 120Ω resistors by default
蓝牙/GPRS/GPS定位 Bluetooth/GPRS/GPS positioning	蓝牙可快速检测分析电池健康状况；GPS实时定位；远程实时查询电池相关信息 Bluetooth can quickly detect and analyze battery health status; GPS real-time positioning; remote real-time query of battery-related information	三合一 Three in one
单体电压掉线检测 Monomer voltage disconnection detection	支持 Support	
单体电压检测 Monomer voltage detection	支持，检测范围1.0V~5.0V Support, detection range 1.0V~5.0V	
总体电压检测 Total voltage detection	检测范围0-20V Detection range 0-20V	
电池类型 Battery type	3.7V三元锂 3.7V NMC 3.2V磷酸铁锂 3.2V LFP	参数可设置 Settable parameter
电池组组合方式 Battery pack combination mode	6-16串 6-16 strings	电池串数可选择 optional battery strings 铁锂最低可支持7串 LFP can support a minimum of 7strings

注：长期超载工作，会损坏保护板，减少其使用寿命。

Note: Long-term overload will damage the protection board and reduce its service life.



3.2、基本功能参数 Basic Functional Parameters

(注：以下参数除特殊注明以外，25°C环温下测试)

(Note: The following parameters are tested at 25°C ring temperature unless otherwise specified)

功能指标项目 Functional Index Item		建议设置参数 Recommended Setting Parameters	设置说明 Setting instructions	备注 Remark
过充保护 (单串电池) Overcharge protection (single string battery)	单体过充保护电压 Single cell overcharge protection voltage	三元4.25V / 铁锂3.65V Ternary 4.25V/ LFP 3.65V	可设 Settable	±20mV
	单体过充保护延时时间 Single cell overcharge protection delay time	1000mS	不可设 Fixed	±500mS
	单体过充保护解除电压 Single cell overcharge protection release voltage	三元4.15V / 铁锂3.5V Ternary 4.15V/ LFP 3.5V	可设 Settable	±20mV
	单体过充保护解除 Single cell overcharge protection release	单体电压下降到恢复点或者放电，自动恢复 When the individual voltage drops to the recovery point or discharges, it automatically recovers.		/
过放保护 (单串电池) Over-discharge protection (single string battery)	单体过放保护电压 Single cell over-discharge protection voltage	三元2.75V / 铁锂2.5V Ternary 2.75V/ LFP 2.5V	可设 Settable	±20mV
	单体过放保护延时时间 Single cell over-discharge protection delay time	1500mS	不可设 Fixed	±500mS
	单体过放保护解除电压 Single cell over-discharge protection release voltage	三元3.0V / 铁锂2.9V Ternary 3.0V/ LFP 2.9V	可设 Settable	±20mV
	过放保护恢复方式 Over-discharge protection and recovery mode	接入充电器或者单体电压上升到恢复点 Connect the charger or the individual voltage rises to the recovery point		/
总体过充保护 Overall overcharge protection	总体过充保护电压 Overall overcharge protection voltage	三元电池组串数 * 4.225V String number of ternary * 4.225V 铁锂电池组串数 * 3.6V String number of LFP * 3.6V	可设 Settable	±1V
	总体过充保护延时时间 Overall overcharge protection delay time	1000mS	不可设 Fixed	±500mS
	总体过充保护解除电压 Overall overcharge protection release voltage	三元电池组串数 * 4.1V String number of ternary *4.1V 铁锂电池组串数 * 3.5V String number of LFP *3.5 V	可设 Settable	±1V



	总体过充保护解除 Overall overcharge protection release	总体电压下降到恢复点或者放电，自动恢复 When the overall voltage drops to the recovery point or discharges, it automatically recovers	/
总体过放保护 Overall over-discharge protection	总体过放保护电压 Overall over-discharge protection voltage	三元电池组串数 * 2.8V String number of ternary * 2.8V 铁锂电池组串数 * 2.5V String number of LFP * 2.5 V	可设 Settable ±1V
	总体过放保护延时时间 Overall over-discharge protection delay time	1500mS	不可设 Fixed ±500mS
	总体过放保护解除电压 Overall over-discharge protection release voltage	三元电池组串数 * 3.1V String number of ternary * 3.1V 铁锂电池组串数 * 2.9V String number of LFP * 2.9 V	可设 Settable ±1V
	充电解除 Charging release	接入充电器或者总体电压上升到恢复点 Connect the charger or the overall voltage rises to the recovery point	/
均衡功能 Equalization function	均衡开启电压 Equalization turn-on voltage	三元3.9V / 铁锂3.3V Ternary 3.9V/ LFP 3.3V	可设 Settable ±20mV
	均衡开启压差 Equalize opening differential	>20mV	不可设 Fixed /
	均衡电流 Equalizing current	100~150 mA	不可设 Fixed /
电芯压差保护 Cell voltage differential protection	单节电芯压差保护电压 Single cell voltage differential protection voltage	>1000mV	可设 Settable ±20mV
内阻 Internal resistance	放电回路内阻 Internal resistance of discharge loop	<40mΩ	/ /
容量默认设置 Capacity default Settings	低电量告警 Low power alarm	SOC < 10%，充电时不告警 SOC < 10%， no alarm during charging	可设 Settable /
	标称容量 Nominal capacity	100AH，需要设置 100AH, needs to be set	可设 Settable /
	低电模式 Low Power Mode	选择设置，建议采用隐藏电量方式 Optional settings, the hidden battery mode is recommended 详细说明参考低电模式说明 For details, please refer to the low power mode description	可设 Settable /



<p>启动器专用 参数说明 Dedicated to the launcher Parameter description</p>	<p>1、启动电流2000A，时间500MS±100 The starting current is 2000A, and the time is 500MS±100</p> <p>2、插上充电器，自动加热【电芯低温状态下】 Plug in the charger and automatically heat the battery (at low temperature)</p> <p>3、可以强制放电、强制加热 Forced discharge and forced heating are possible</p>	<p>需软件配套支持 【8串铁锂专用】 Require software support (8 strings of LFP only)</p>
----------------------------------------------------------------------------------------------	--------------------------------------------------------------------------------------------------------------------------------------------------------------------------------------------------------------------------------------------------------------------------------------	-----------------------------------------------------------------------------------------------



功能指标项目 Functional Index Item		建议设置参数 Recommended Setting Parameters				设置说明 Setting Instructions	备注 Remark
短路保护 Short circuit protection	短路保护电流 Short circuit protection current	150A: 2000A±15% 200A: 2500A±15%				不可设 Fixed	/
	短路保护延时时间 Short circuit protection delay	200~800μS				不可设 Fixed	/
	短路保护解除方 Short circuit protection released mode	断开负载; 鉴于短路电流特别大, 避免危险不建议客户做短路测试. Disconnect the load; Due to the high short-circuit current, it is not recommended for customers to conduct short-circuit testing to avoid danger.					/
充电过流保护 Charging over-current protection	充电过流保护 Charging over-current protection	电流值 Current value		持续时间 Duration	恢复延时 Delay recovery	/	/
		150A	200A				
	充电过流3 Charging over-current 3	75A±2A	100A±2A	120S±2S	30S±2S	可设 Settable	/
	充电过流2 Charging over-current 2	105A±2A	140A±2A	30S±2S	30S±2S	可设 Settable	/
	充电过流1 Charging over-current 1	135A±2A	180A±2A	10S±2S	30S±2S	可设 Settable	/
	充电过流保护解除 Charging over-current protection release	延时后自动恢复 Automatic recovery after delay					/
放电过流保护 Discharging over-current protection	放电过流保护 Discharging over-current protection	电流值 Current value		持续时间 Duration	恢复延时 Delay recovery	/	/
		150A	200A				
	放电过流3 Discharging over-current 3	165A±2A	220A±2A	60S±2S	30S±2S	可设 Settable	/
	放电过流2 Discharging over-current 2	187A±2A	250A±2A	10S±2S	30S±2S	可设 Settable	/
	放电过流1 Discharging over-current 1	225A±2A	300A±2A	5S±2S	30S±2S	可设 Settable	/
	放电过流保护解除 Discharging over-current protection release	延时后自动恢复 Automatic recovery after delay				/	/



MOS温度保护 MOS temperature protection	MOS高温保护温度 MOS high temperature protection	85°C	可设 Settable	±3°C
	MOS高温保护解除温度 Release temperature of MOS high temperature protection	70°C	可设 Settable	±3°C
	MOS低温保护温度 MOS low temperature protection	-20°C	可设 Settable	±3°C
	MOS低温保护解除温度 Release temperature of MOS low temperature protection	-15°C	可设 Settable	±3°C
电芯温度保护 Cell temperature protection	充电高温保护温度 Charging high temperature protection temperature	60°C	可设 Settable	±4°C
	充电高温保护解除温度 Charging high temperature protection release temperature	50°C	可设 Settable	±4°C
	充电低温保护温度 Charging low temperature protection temperature	-15°C	可设 Settable	±4°C
	充电低温保护解除温度 Charging low temperature protection release temperature	-10°C	可设 Settable	±4°C
	放电高温保护温度 Discharge high temperature protection temperature	65°C	可设 Settable	±4°C
	放电高温保护解除温度 Discharge high temperature protection release temperature	55°C	可设 Settable	±4°C
	放电低温保护温度 Discharge low temperature protection temperature	-20°C	可设 Settable	±4°C
	放电低温保护解除温度 Discharge low temperature protection release temperature	-15°C	可设 Settable	±4°C

说明：以上数据均为25°C环境下测试，若不在25°C测试，测试数据可能会引起偏差。

BMS保护参数都具有上述功能，参数可能会有所变动更新，改动不做另行通知，请以实际为准。所有保护参数如需修改，需向保护板厂家提出申请。

Note: The above data are tested at 25 ° C. If not tested at 25 ° C, the test data may cause deviation.

The BMS protection parameters all have the above functions. The parameters may be changed without prior notice. If all protection parameters need to be modified, apply to the manufacturer of the protection board.



3.3、GPS规格参数 GPS Specifications

此型号自带智能型低成本的GPS定位功能，它融合了GSM无线通信技术及GPS系统定位技术，终端采用工业级高集成度设计，可使用电脑端后台或者手机APP控制电池的充放电，配合BMS保护板对电池充放电智能控制，实时掌握电池的使用情况，保证电池的安全性，优化电池使用寿命，方便电池和车辆的维护管理。

This model comes with intelligent low-cost GPS positioning function. It integrates GSM wireless communication technology and GPS system positioning technology. The terminal adopts industrial high integration design and can use the computer end background or mobile phone APP to control the battery charging and discharging, with BMS protection board intelligent control of battery charging and discharging, real-time grasp the use of the battery, which can ensure the safety of the battery, optimize the battery life, and facilitate the maintenance and management of the battery and vehicle.

1、实时定位：通过GPS卫星定位，可远程掌握电池运行状态。

Real-time positioning: Through GPS satellite positioning, you can remotely grasp battery operating status.

2、轨迹回放：平台上可保存行车记录，方便回放，同时回放过程中可以查看车辆的轨迹、停留及停留时间、当时的速度和里程等。

Track playback: Driving records can be saved on the platform for easy playback, and the track, stay and stay time, speed and mileage of the vehicle can be viewed during the playback process.

3、里程统计：可以查看车辆每日、周、月的里程统计报表及总里程，在手机上轻松管控每一辆车。与电池充放电循环次数一起作为售后维护的依据。

Mileage statistics: Daily, weekly, monthly mileage reports and total mileage can be viewed on the mobile phone for easy management of each vehicle. Together with the number of battery charging and discharging cycles, it is used as the basis for after-sales maintenance.

4、盲区补传功能：终端定位盲区自动储存数据，有信号正常上线时上传。

Blind area supplement function: The terminal automatically stores data in areas with poor signal coverage and uploads it when a signal is available.

3.4、低功耗及唤醒 Low Power and Wake-up

3.4.1 休眠模式及唤醒 Sleep Mode and Wake-up

保护板检测到电池静止一段时间后，保护板进入待机休眠状态，降低功耗；电池放电运动时保护板自动唤醒工作。

When the protection board detects that the battery has been idle for a period, it enters standby sleep mode to reduce power consumption. The protection board automatically wakes up and operates when the battery discharges.

3.4.2 深度睡眠模式及唤醒 Deep Sleep Mode and Wake-up

方式一：电池电压偏低时【电池单串电压铁锂<2.1V、三元<2.5V】，保护板会关机进入深度睡眠模式，防止将电量耗尽损坏电池。

Method 1: When the battery voltage is low (single string voltage, LiFePO4 < 2.1V, Ternary < 2.5V), the protection board shuts down and enters deep sleep mode to prevent battery damage from over-discharge.

方式二：需要较长时间运输或存储时，也可以手动下发关机指令，让保护板关机进入深度睡眠模式，保留电量。

Method 2: For long-term transportation or storage, a manual shutdown command can be issued to put the protection board into deep sleep mode, preserving battery power.

唤醒方式：电池投入使用前需采用充电或者使用开机唤醒键让保护板开机才能正常使用

Wake-up Methods: Before using the battery, it must be activated by either charging or using the wake-up button to turn on the protection board for normal operation.



3.5、显示屏功能 Display Function

本智能软件板使用RS485接口来支持屏幕显示电池组状态，电池电压、电流、单体电压、温度等相关电池信息。

The intelligent software board uses RS485 interface to support the screen display of battery pack status, battery voltage, current, cell voltage, temperature and other related battery information.

四、通信说明 Communication Description

4.1、LTE通信 LTE Communication

BMS 可以通过LTE进行通讯，从而在平台查看电池的各种信息。

BMS can communicate over LTE to view various information about the battery on the platform.

4.2、RS485通信 RS485 Communication

本产品支持RS485通信接口功能，可支持显示屏功能。

The product supports RS485 communication interface and display screen function.

BMS 可以通过RS485 接口与上位机进行通讯，从而在上位机端查看电池的各种信息。默认波特率为9600bps。

The BMS can communicate with the upper computer through the RS485 interface, so as to view various information of the battery on the upper computer. The default baud rate is 9600bps.

◆此为可选配功能。

This is optional.

4.3、CAN通信 CAN Communication

本产品支持CAN通信接口功能，可支持显示屏功能。

The product supports the CAN communication interface, and it can support display screen function.

BMS 可以通过CAN接口与上位机进行通讯，从而在上位机端查看电池的各种信息。

The BMS can communicate with the upper computer through the CAN interface, so as to view various information of the battery on the upper computer.

◆此为可选配功能。

This is optional.



五、BMS保护板尺寸图 BMS Protection Board Dimensions

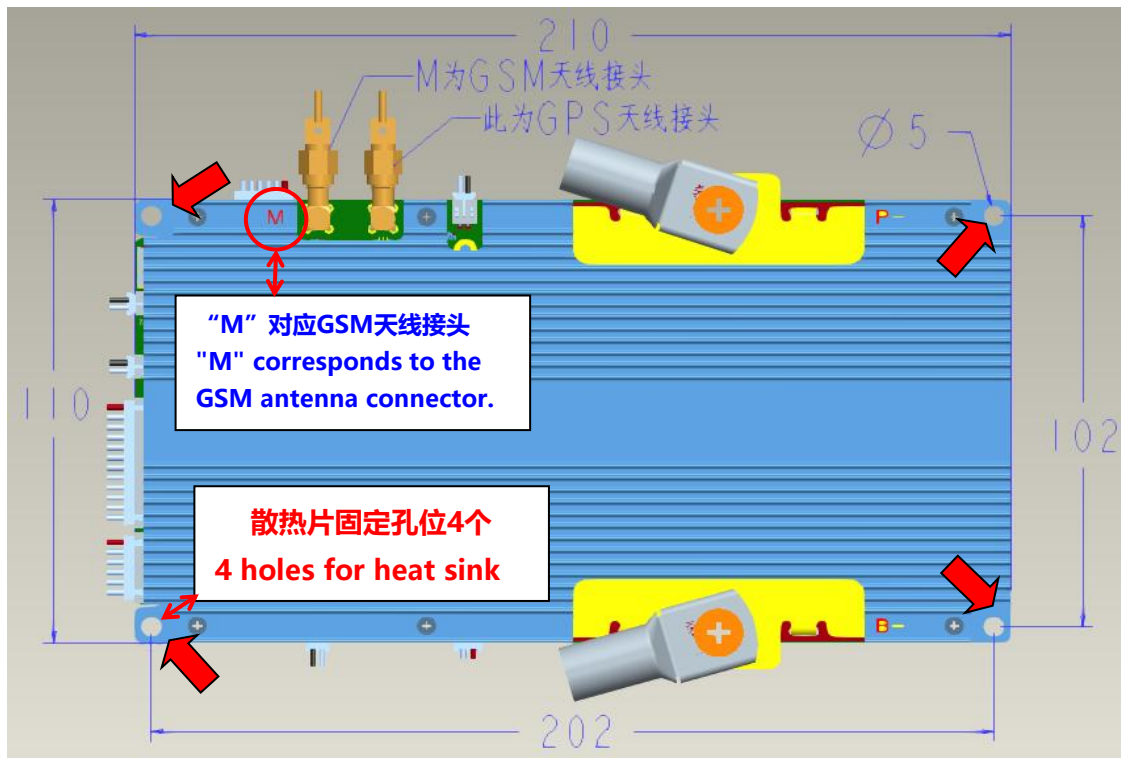

保护板尺寸：210*110*21【固定孔位中心尺寸202*102】 (mm)

Size of protection board : 210*110*21 [fixed hole center size 202*102] (mm)

■ **重要说明：**保护板散热片可以通过上图所示的定位孔固定在电池铁箱外壳或者增加的铝板上辅助散热，接触面要增加导热硅脂或导热硅胶片来导热。

■ **Important notice:** The heat plate of the protection board can be fixed on the battery iron box shell or the additional aluminum board through the positioning hole shown in the above figure to assist heat dissipation. The contact surface should be equipped with thermal conductive silicone grease or thermal conductive silicone sheet to conduct heat.

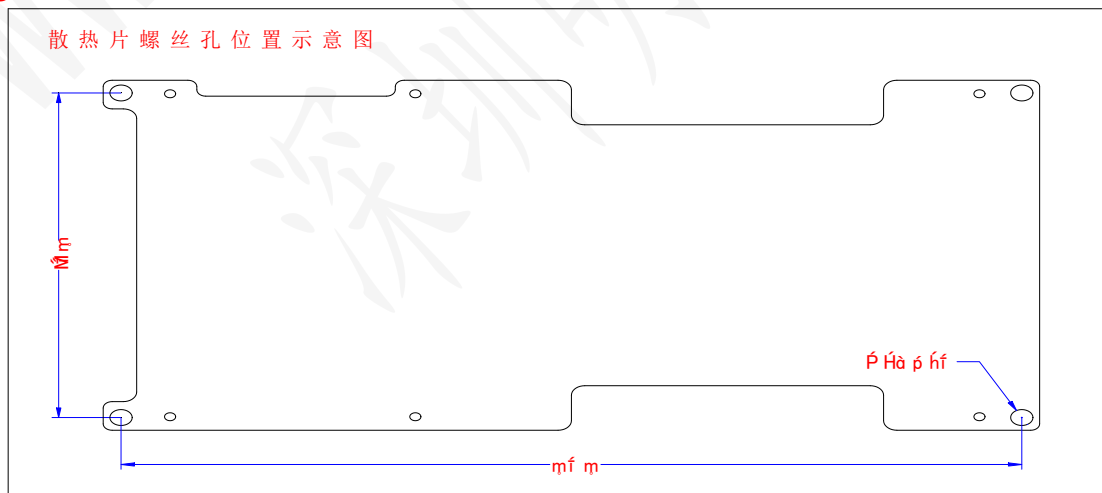

散热片螺丝孔位置示意图

Schematic diagram of screw holes position for heat sink



六、参考图及安装说明 Reference Diagram and Installation Instructions

6.1、保护板元件视图 Protection Board Component View

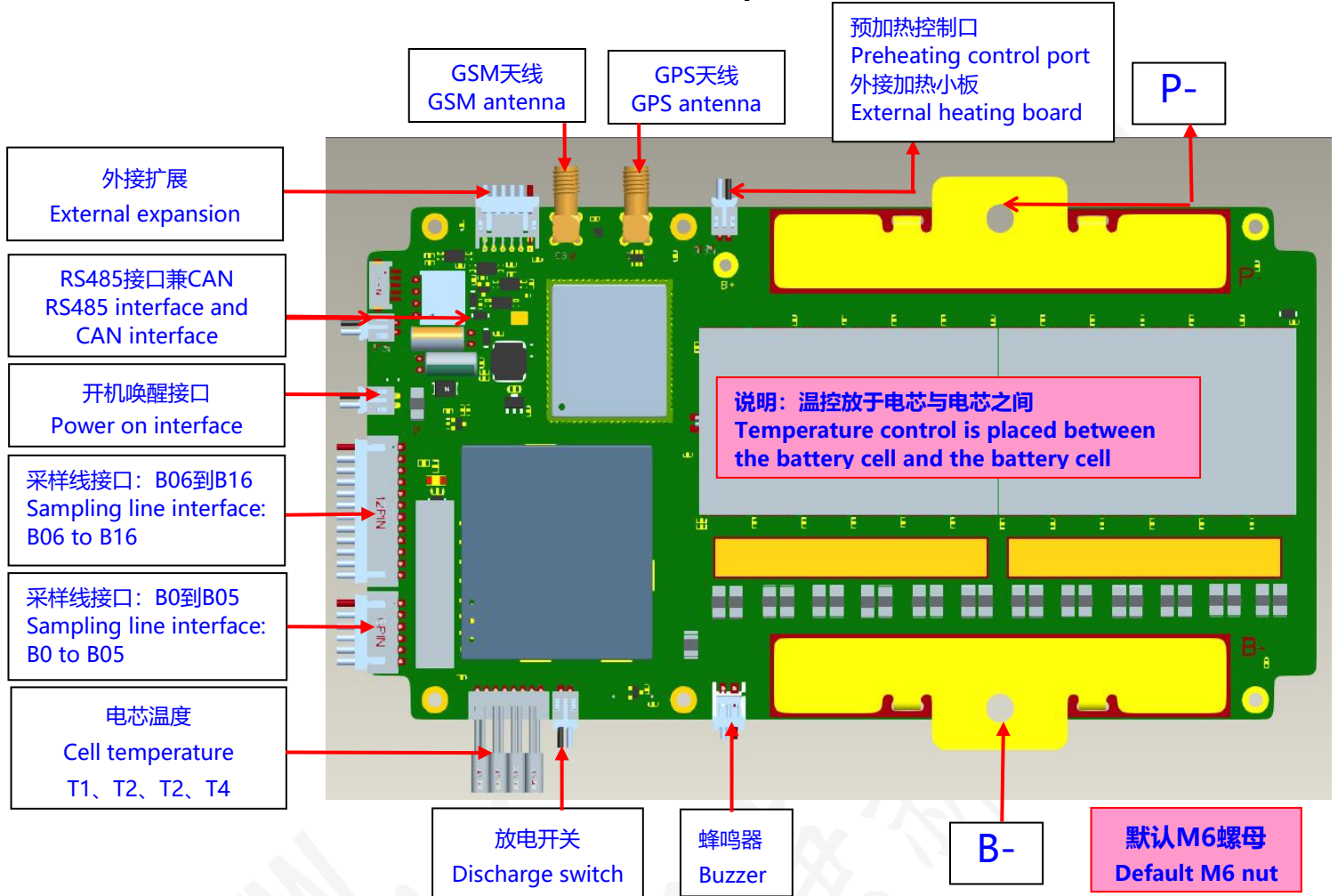

以上图片仅供参考，实物以配置表或封样为准。

The images above are for reference only. The actual product will be determined by the specification sheet or the sealed sample.

BM566接插件详细型号说明

Detailed model description of BM566 connector

接口功能 Interface function	接口详细型号 Detailed interface model	接口功能 Interface function	接口详细型号 Detailed interface model
开机唤醒 Power on wake-up	PH2. 0-2P	RS485&CAN	ZH1. 5-5P
放电开关 Discharge switch	PH2. 0-2P	温度线 (4路) Temperature line (4 channels)	PH2. 0-8P
预加热 Preheating	PH2. 0-2P	采样线 Sampling line	XH2. 5-6P+12P
蜂鸣器 Buzzer	EH2. 5-2P (5V有源) EH2. 5-2P (5V active)	扩展接口 Expansion interface	PHD2. 0双排-2x6p PHD2. 0 double row-2x6p



重要说明：电池采样线材、温度线、RS485通讯线等插接的线材，装好后要打胶固定，防止电池使用过程中震动脱落。

Important note: The battery sampling wires, temperature wires, RS485 communication wires, etc., should be glued and fixed after installation to prevent them from loosening or detaching due to vibrations during battery use.

相关接口功能说明【电池箱外壳需要开孔增加相应的按钮及接线处理】：

Description of relevant interface functions [The battery box casing requires drilling to add corresponding buttons and wiring processing].

■ **放电开关：放电控制开关，闭合时可以放电，断开后不能放电【如果需要使用此功能，软件需要更新】**

Discharge Switch: A control switch for discharging. Discharging is possible when the switch is closed and not possible when it is open. [Software updates are required to use this feature.]

(使用：接上控制器或者其他负载之前，放电开关断开；确认电池完全连接上负载后再闭合开关，开始使用电池。) ——【开关建议使用自锁式开关：按下打开，再按关闭】

Usage: Disconnect the discharge switch before connecting to a controller or other load. Ensure the battery is fully connected to the load before closing the switch to start using the battery. — [It is recommended to use a self-locking switch: press to turn on, press again to turn off.]

■ **开机唤醒：开机激活开关，电池深度休眠关机状态下，可以直接使用此开关激活开机【2PIN短接2-3秒即可激活开机，开机后要断开】。 ——【开关建议使用复位式开关：按下去打开，松开后关闭】**

Power-on Wake-up: This is a power activation switch. When the battery is in a deep sleep shutdown state, this switch can be used to activate and power on the system. [2PIN short circuit 2-3 seconds can activate and power on, and disconnect after booting]

— (It is recommended to use a reset switch: press to turn on, release to turn off.)



接线示意图参考 Wiring schematic reference

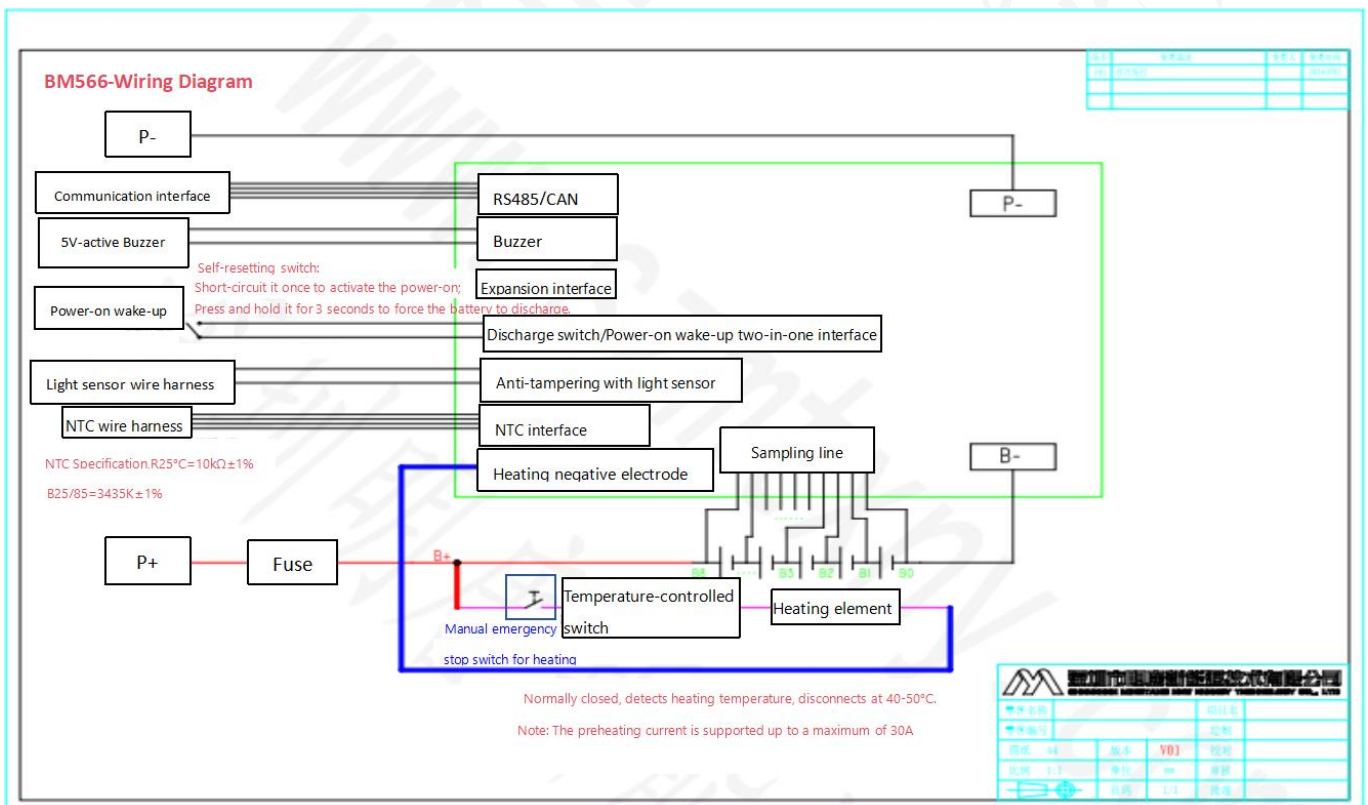
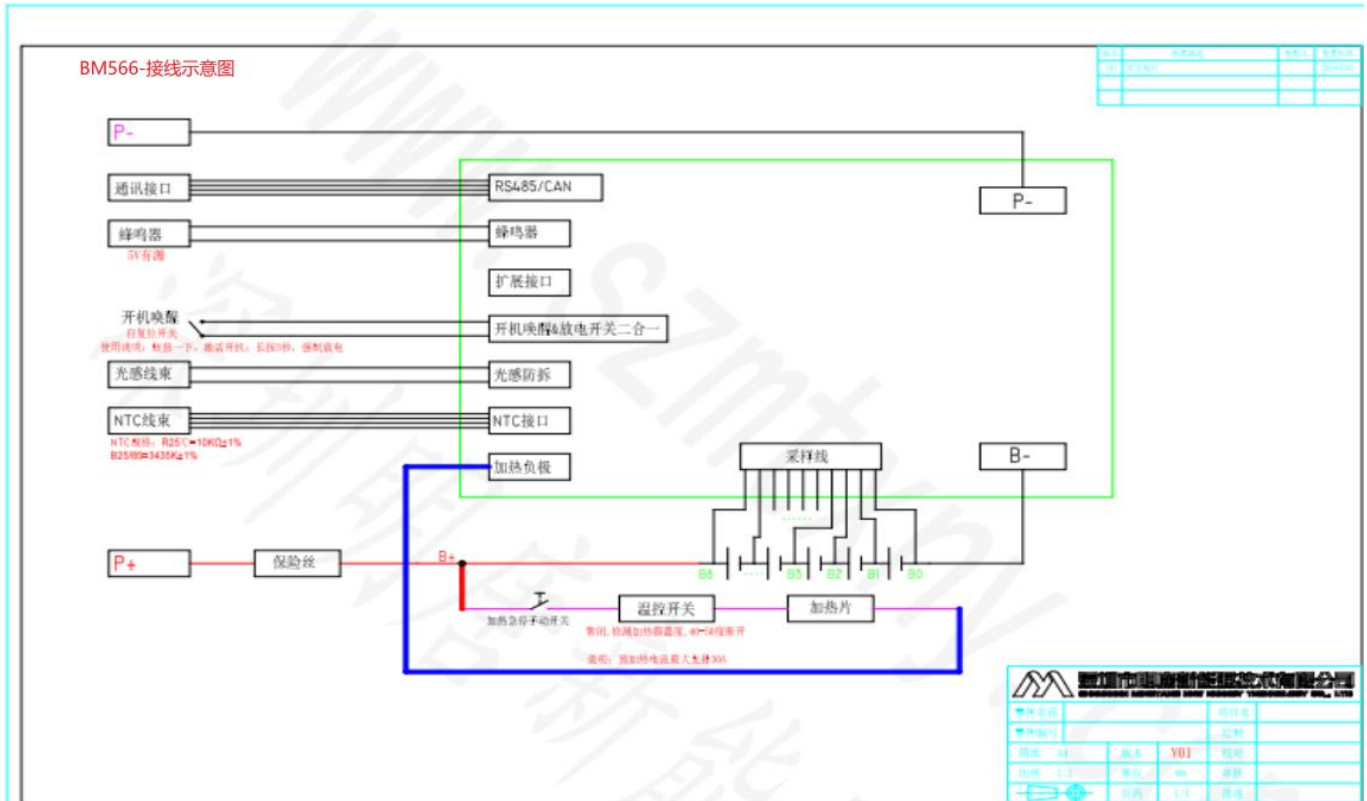

发热丝加热的接线示意图请参考上图，充电时加热【电芯低温才能开启发热丝加热功能】。

Please refer to the above diagram for the wiring schematic of the heating wire heating, heating while charging [The heating wire heating function can only be turned on when the core is cold].



6.2、 电池采样线接线定义 Battery Sampling Line Wiring Definition

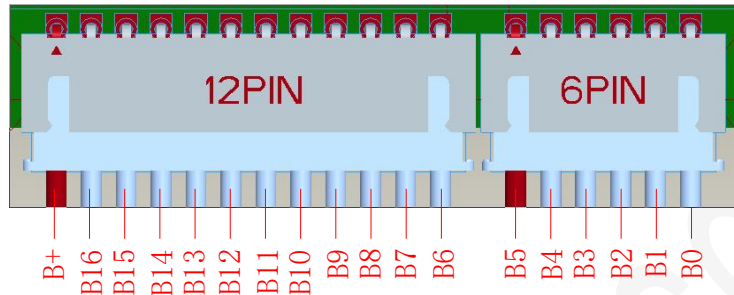

相关说明：采样排线的走线排布不要扯太紧，以免使用过程中拉扯松脱；主板插座和排线结合处要打胶固定。

Instructions: The routing of the sampling wiring harness should not be too tight to avoid being pulled loose during use; the junction between the motherboard socket and the wiring harness should be secured with adhesive.

【注意焊排线时排线切不可插在保护板上上面去焊接，排线接好后不能直接插均衡仪进行均衡】

Notice: When soldering the wiring harness, do not solder it while it is plugged into the protection board. After connecting the wiring harness, do not directly plug it into the balancing instrument for equalizing.

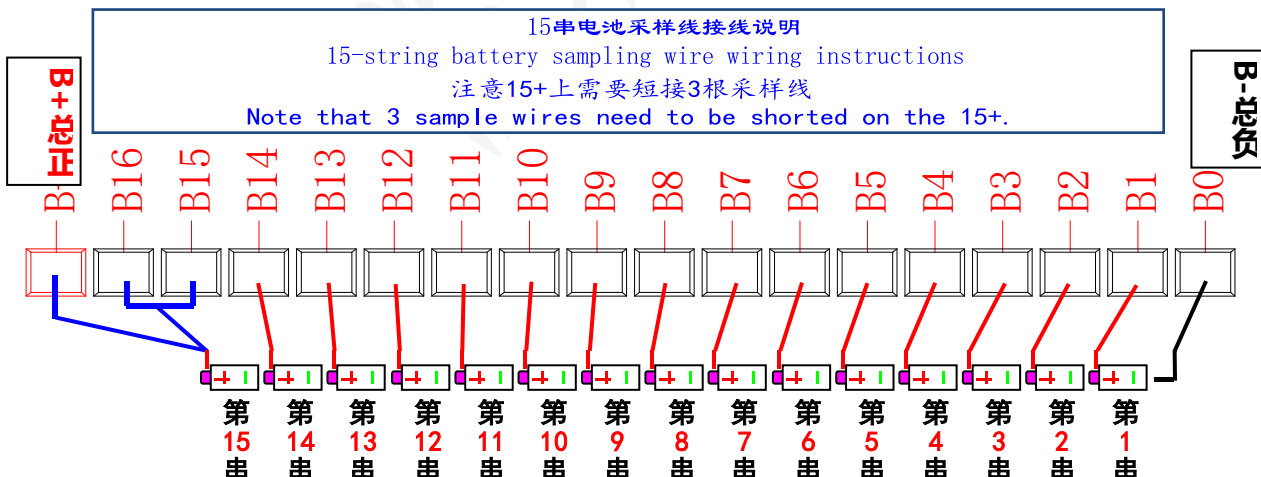
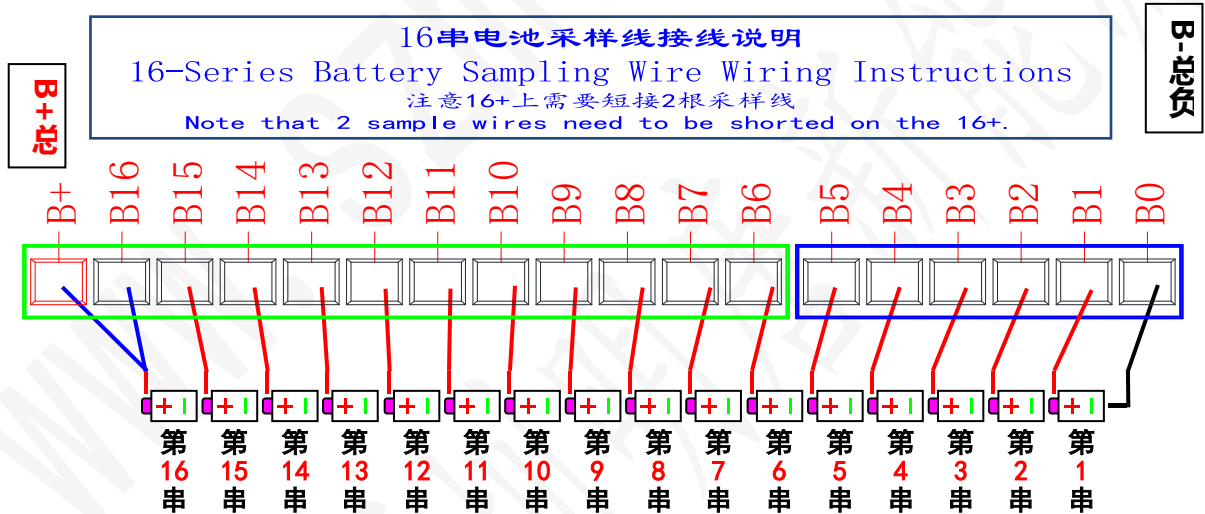

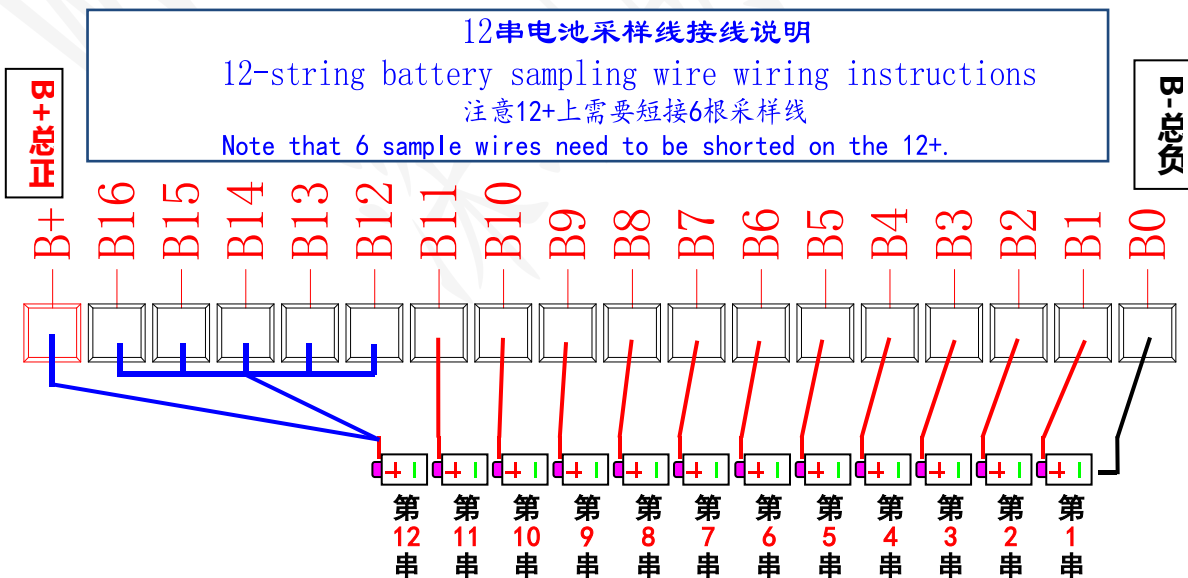
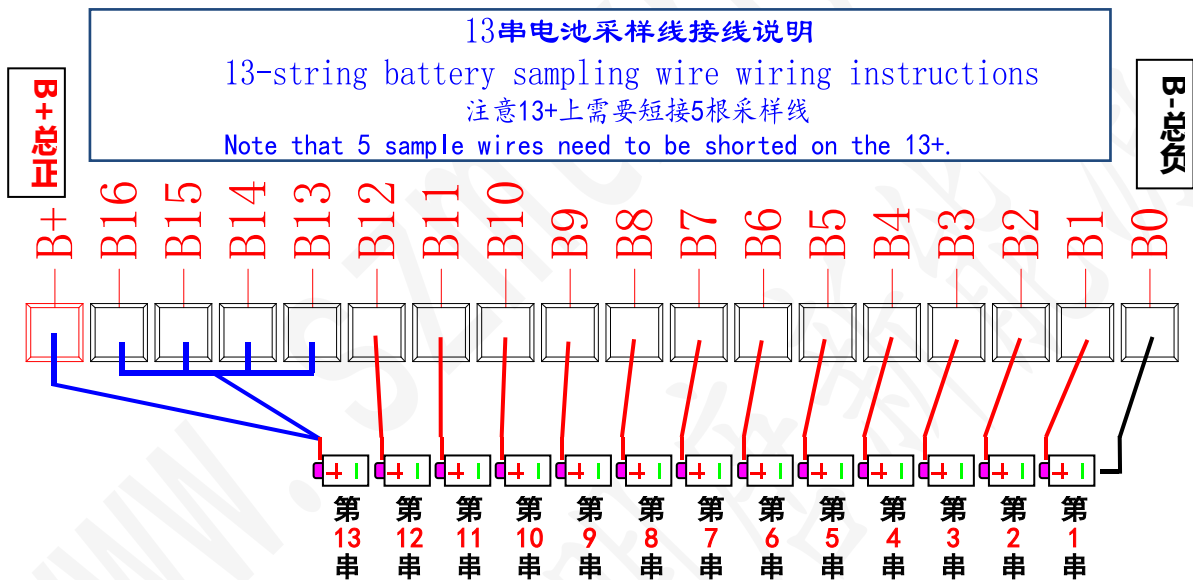
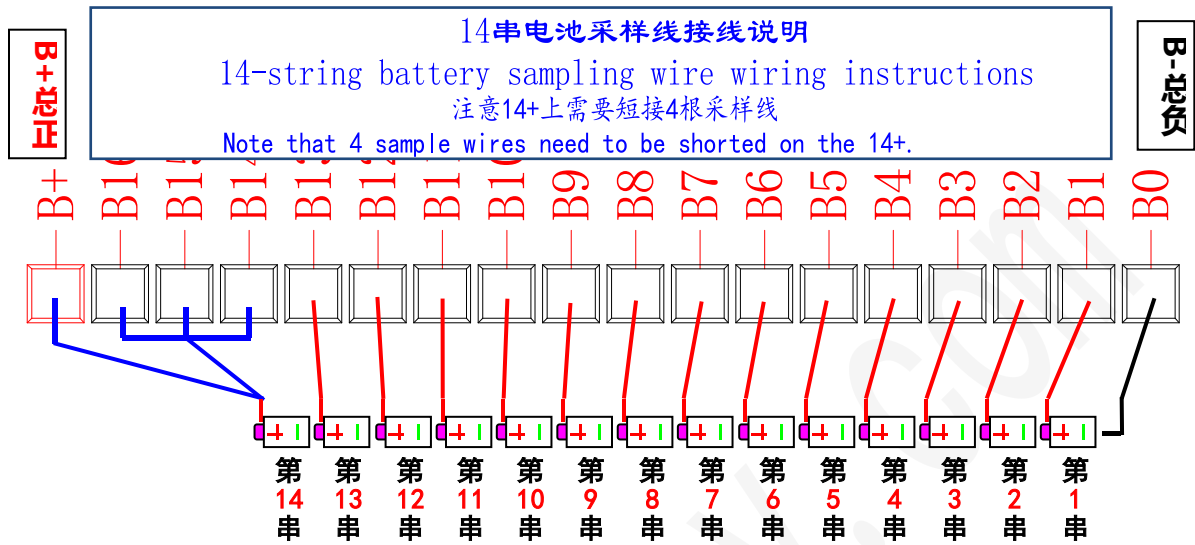

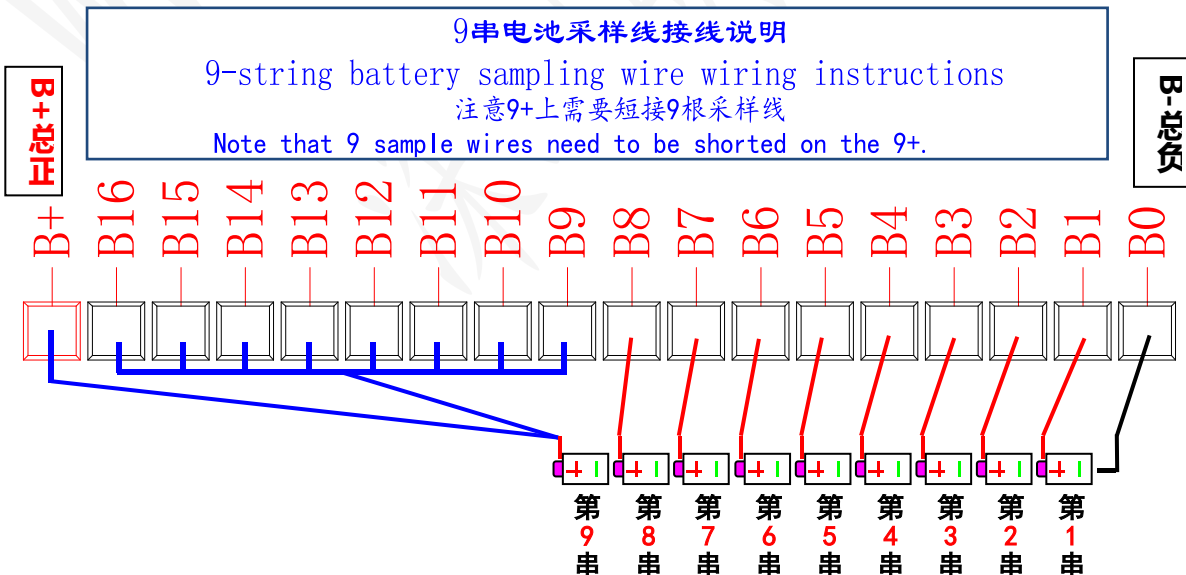
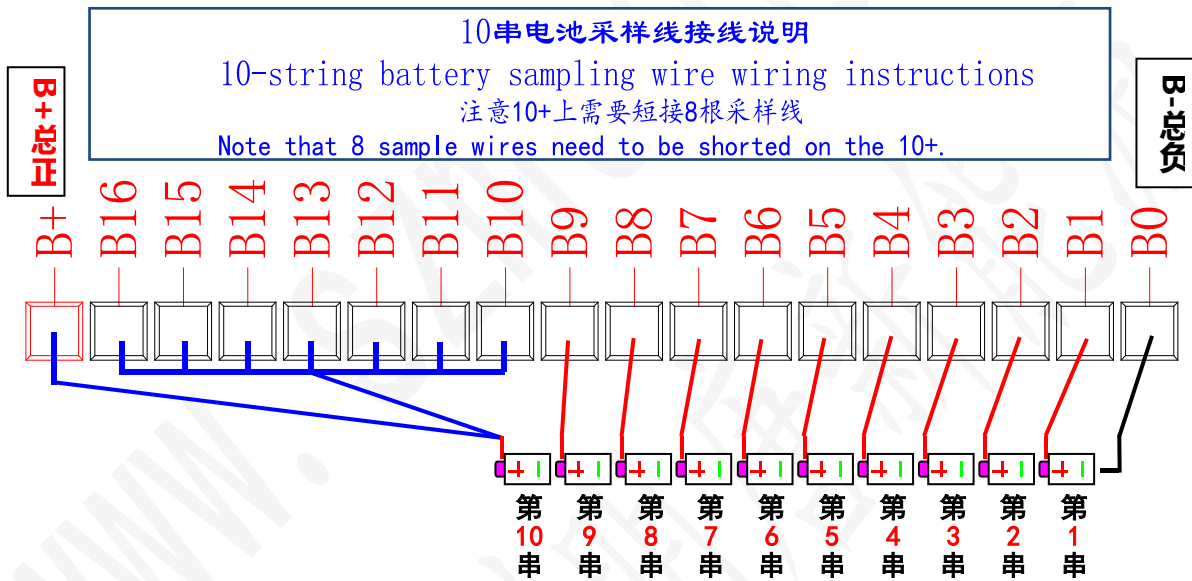
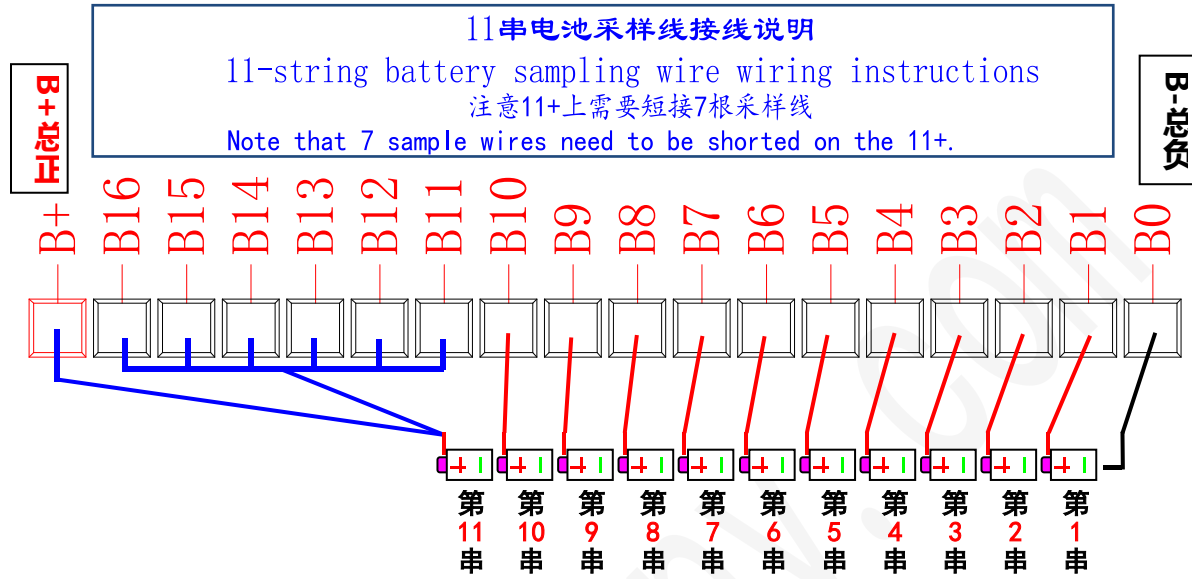

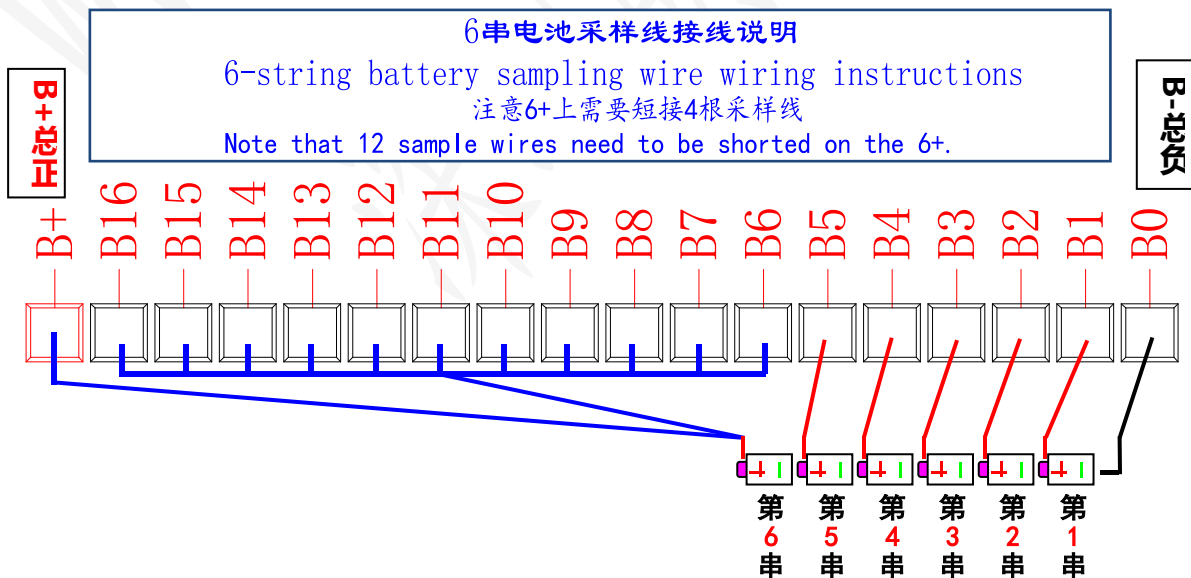
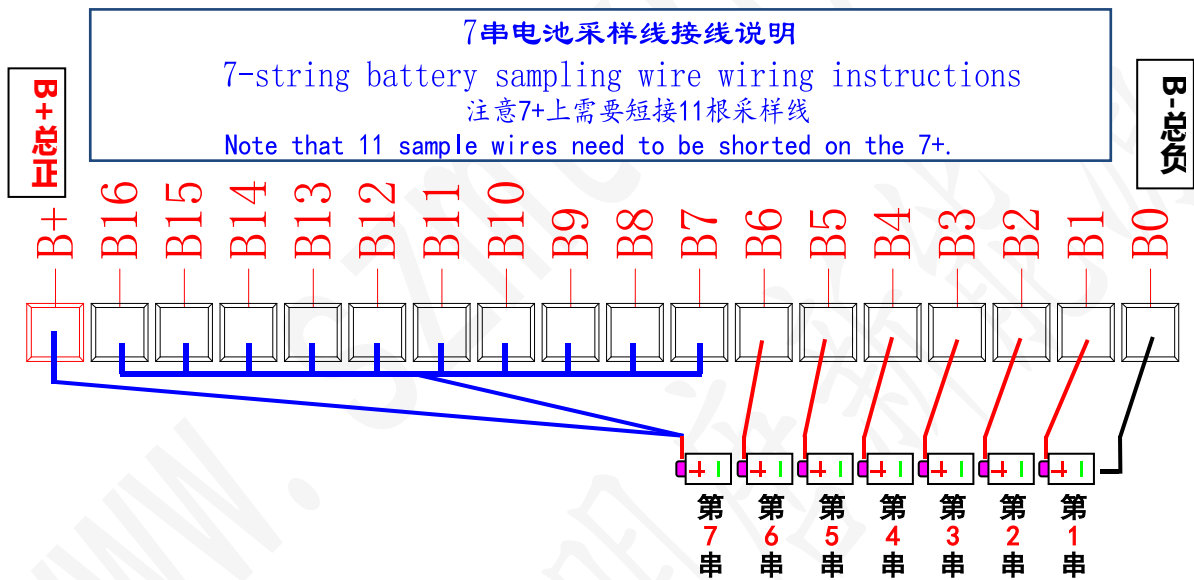
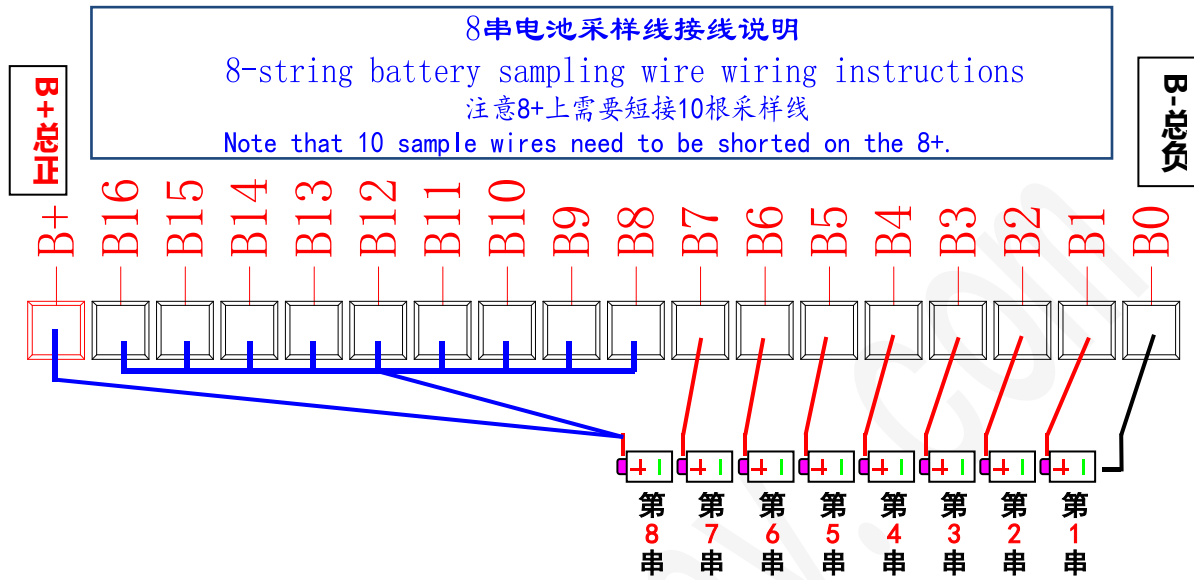



6.3、RS485&CAN通信接口说明——【可选配功能】

Description of RS485 and CAN Communication Interface - (Optional Features)

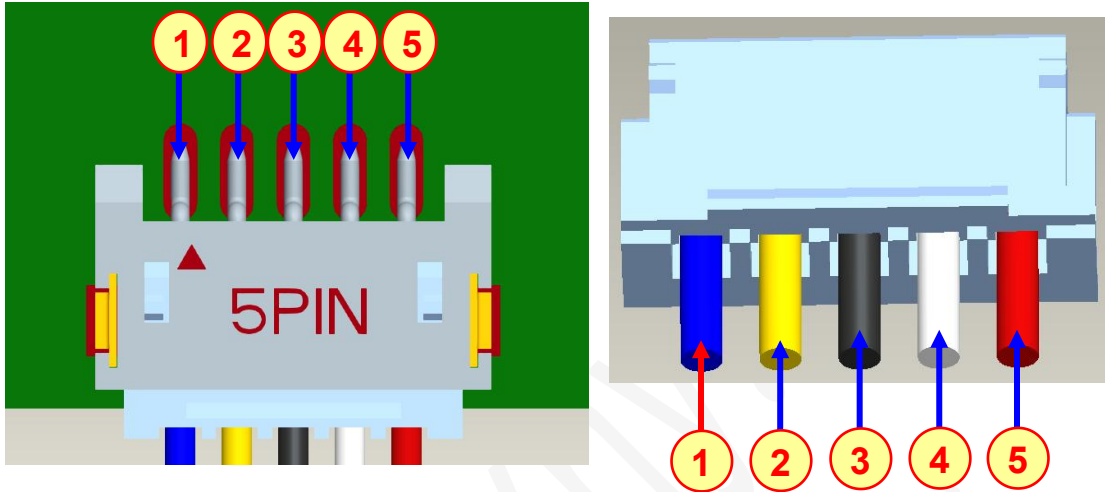

RS485&CAN—— 采用ZH1.5间距-5PIN，外接线端可自定义 RS485 & CAN — Uses ZH1.5 pitch-5PIN, external wire ends can be customized.		
引脚 PIN	定义说明 Definition	默认接线颜色 Default wiring color
1	CAN _ H	蓝色 Blue
2	CAN _ L	黄色 Yellow
3	GND	黑色 Black
4	RS485 _ A	白色 White
5	RS485 _ B	灰色或红色 Gray or red



6.4、温度采集接口说明 Temperature Acquisition Interface Description

温度采集4路——采用PH2.0间距-8PIN 4 channels of temperature acquisition -- using PH2.0 spacing -8PIN			
NTC规格: $R_{25}=10K\Omega\pm 1\%$, $B_{25/85}=3435K\pm 1\%$			
NTC specifications: $R_{25}=10K\Omega\pm 1\%$, $B_{25/85}=3435K\pm 1\%$			
	引脚 PIN	定义说明 Definition	备注 Remark
	1	NTC1-	
	2	NTC1+	
	3	NTC2-	
	4	NTC2+	
	5	NTC3-	
	6	NTC3+	
	7	NTC4-	
8	NTC4+		



6.5、安装连接说明 Installation and Connection Instructions

警告：把保护板连接至电芯，或从电池组拆下保护板时，必须遵守以下连接顺序与规定；如果不按要求的顺序作业，会损坏保护板的元器件，从而导致保护板不能保护电芯，造成严重的后果。

Warning: When connecting the protection board to the battery cell, or when removing the protection board from the battery pack, the following connection sequence and regulations must be adhered to. If the work is not performed in the required sequence, the components of the protection board will be damaged, resulting in the protection board failing to protect the cell and causing serious consequences.

A、连接保护板的步骤 Steps for connecting a protection board

准备工作：先把采样排线连接在电池组电芯上，检查排线连接正确

【切记：不能把排线插在保护板上再一根一根连接在电池组电芯上】

Preparation: First connect the sampling line to the battery pack cell and check that the cable is connected correctly. **[Remember: do not plug the cable into the protection board and then connect it to the battery pack cell one by one]**

- 1) 连接电池组的负极B-；
Connect the negative electrode B- of the battery pack;
- 2) 连接输出负载的负极P-；
Connect the negative terminal P- of the output load;
- 3) 连接电池组的采样排线； **（先插低压排线【带黑色线材的】，再插高压排线【带红色线材的】）**

Connect the sampling line of the battery pack; **(First insert the low voltage bar cable [with black wire], then insert the high voltage bar cable [with red wire])**

- 4) 所有连接线安装好，再插入充电器激活保护板开机， **确认电池总电压与保护板输出电压相等；**

重点确认 Attention

Install all the cables, and then insert the charger to activate the protection board to start, **and ensure that the total battery voltage is equal to the output voltage of the protection board;**

B、断开保护板的步骤 Steps for disconnecting the protection board

- 1) 断开负载或者充电器；
Disconnect the load or charger;
- 2) 断开电池组正极的B+连接线；
Disconnect the B+ connection line of the positive electrode of the battery pack;
- 3) 拔下电池组的采样排线； **（先拔高压排线【带红色线材的】，再拔低压排线【带黑色线材的】）**

Unplug the sampling line of the battery pack; **(First pull out the high pressure wire [with red wire], and then pull out the low pressure wire [with black wire])**

- 4) 断开电池组负极的B-连接线；
Disconnect the B-connection wire of the negative battery pack;

特别说明：在此环节中要注意静电的防护。特别要注意生产的烙铁漏电问题。

Special note: Pay attention to the protection of static electricity in this link. Pay special attention to the production of soldering iron leakage problem.



6.6、保护板激活开机说明 Protection Board Activation and Power-on Instructions

1、新装电池包 New battery pack

首先保护板需要按照上面的对应串数接线图，正确接好所有线，确认OK，新装的电池包保护板接口外露的，可以使用开机唤醒方式激活保护板开机，板上红色指示灯闪亮，说明保护板开机OK。

First of all, the protection board needs to be correctly connected according to the corresponding string number wiring diagram above, and confirm OK. If the interface of the newly installed battery pack protection board is exposed, you can activate the protection board to start up by using the wake-up mode. The red indicator on the board is shining, indicating that the protection board is OK to start up.

2、组装完成封箱的电池组 Assembled and sealed battery pack

BMS保护板在电芯电压低于保护值或者下发关机指令，进入关机状态后，需要采用充电的方式【充电电流>1A】激活保护板开机才能正常使用。

When the battery voltage of the BMS protection board is lower than the protection value or the shutdown command is issued, and it enters the shutdown state, it is necessary to activate the protection board by charging [charging current > 1A] to start up.

保护板开机成功后，可以使用上位机程序、手机APP、电脑端平台等确认保护板运行情况。

After the protection board is successfully started, you can use the upper computer program, mobile phone APP, computer terminal platform, etc., to confirm the operation of the protection board.

【说明：需要较长时间运输或者存储时，可以下发关机指令，让保护板关机进入低功耗模式，投入使用前需充电激活保护板开机才能正常使用】

(Notice: When it takes a long time for transportation or storage, the shutdown command can be issued to shut down the protection board and enter the low power consumption mode. Before putting into use, the protection board needs to be charged and activated to start up.)



七、天线把手安装说明 Antenna Handle Installation Instructions

7.1、天线把手实物及尺寸图：Antenna Handle and Its Dimension Drawing

说明：把手可承重75Kg。

Description: Handle can bear 75Kg.



把手对应钻孔尺寸参考图，注意居中放置
Place the handle in the center according to the reference drawing of the drilling size

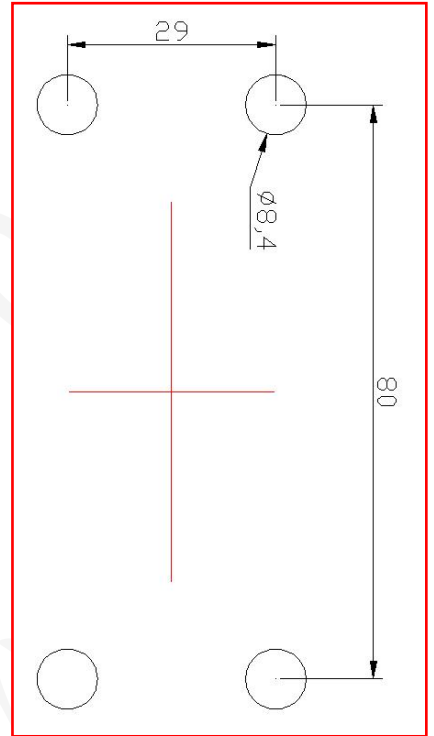

TOLERANCE UNLESS OTHERWISE SPEC.	
0.0-5.0	±0.05
5.0-10.0	±0.08
>10.0	±0.13
ANGLE	≤±0.1°

工程确认		AMEND		深圳市明唐新能源技术有限公司	
SMT生产	△			PART NO. 把手	PRODUCT NO. REV V01
硬件测试	△			DWN	DSN
工厂制造	△			CHKD	APPD
LAYOUT	△			SCALE:	UNIT: mm SHEET: 分页号
HW	NO.	CONTENT	DATE		



7.2、天线把手安装要求 Antenna Handle Installation Requirements:

7.2.1、电池外箱钻孔尺寸及注意事项【为了确保天线信号达到最佳状态】:

Battery outer box drilling size and precautions [to ensure optimal antenna signal reception]:

◆ 在外箱居中位置放置钻孔尺寸

Place the drill hole dimensions in the middle position of the outer box.

◆ 把手安装方向: 把手的长边与外箱上盖的长边垂直

Handle installation direction: the long side of the handle is perpendicular to the long side of the cover of the outer box.



电池外箱上壳

Battery outer box upper

GSM

注意如图放置孔位, 这样天线的信号才能达到最佳。
Pay attention to the position of the hole as shown in the figure, so that the antenna signal can reach the best.

保护板设备号粘贴位置, 上下位置可选择
The position for attaching the device number of the protection board is optional

GPS

字母“S”对应GPS天线
"S" ---- GPS antenna
字母“M”对应GSM天线
"M" ---- GSM antenna

把手安装方向: 把手长边与铁壳长边垂直

Handle mounting direction:

The long side of the handle is perpendicular to the long side of the iron case

天线把手安装注意事项

Antenna handle installation precautions





7.2.2、天线支架安装注意事项 Antenna support installation precautions

- 把手螺柱插入孔中，将天线支架装入孔中，**天线要与把手的天线标识相对应，否则天线信号会不好。**

Insert the handle stud into the hole, and put the antenna bracket into the hole. **The antenna should correspond to the antenna identification of the handle, otherwise the antenna signal will be bad.**

- 注意安装时不要撕掉黑色绝缘泡棉，防止短路。

Do not tear off the black insulation foam during installation to prevent short circuit.

- 螺母一定要锁紧，压紧天线支架金属，保证接触导通。**

The nut must be locked, and the metal of the antenna support must be pressed tightly to ensure contact conduction.

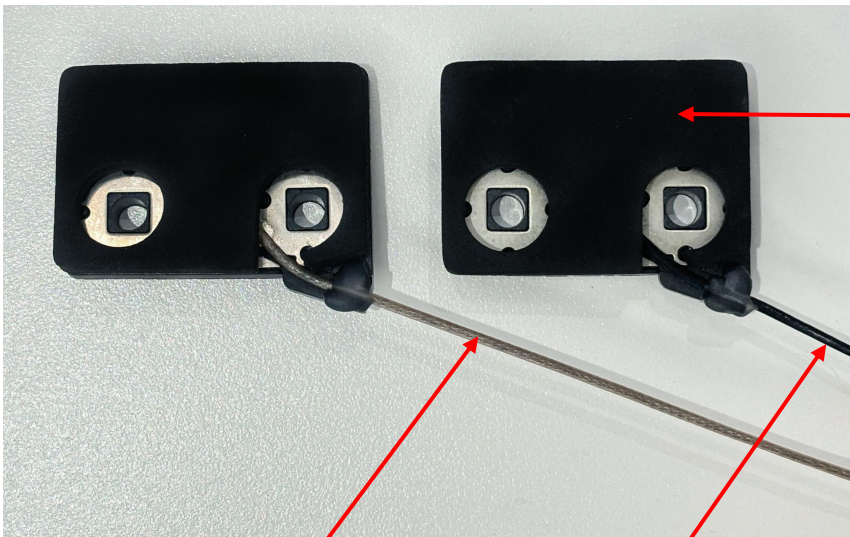

注意：安装时，请不要撕掉此黑色绝缘泡棉，防止短路。

Notice: During installation, please do not tear off the black insulation foam to prevent short circuit.

说明：天线长度300mm±10左右
Notice: The antenna length is about 300mm±10

棕线为GSM天线

The brown one is GSM antenna

黑线为GPS天线

The black one is GPS antenna

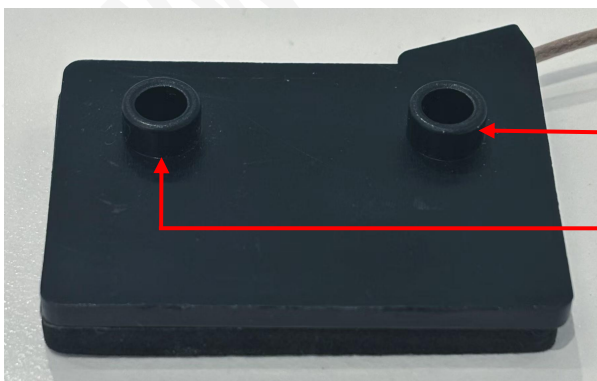

注意：切记箭头所指骨位不要切掉，起绝缘限位作用。

Notice: Remember not to cut off the bone position indicated by the arrow, as it serves as an insulation limit.

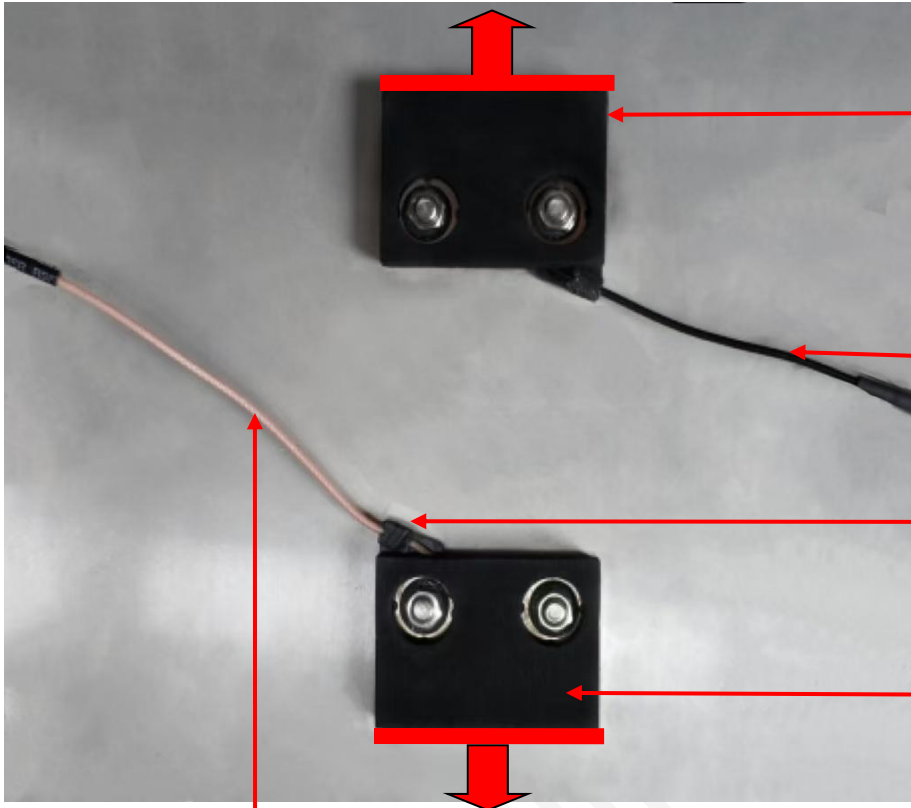

注意：钢片天线的横梁朝外安装
Note: The beam of the sheet steel antenna is mounted outwards

注意：GPS天线与把手的“S”对应
Note: The GPS antenna corresponds to the "S" on the handle

黑线为GPS天线
The black one is the GPS antenna

线束端朝内
The end of the harness faces inward

由于产品天线性能需要，把手螺杆会比普通把手的长，所需要的空间会大，需要评估确认空间，防止使用中顶到电芯造成异常。

Due to the performance requirements of the product antenna, the handle screw will be longer than that of a standard handle, requiring more space. It is necessary to assess and confirm the available space to prevent the handle from contacting the battery cell and causing abnormalities

棕线为GSM天线
The brown one is a GSM antenna

注意：GSM天线与把手的“M”对应
Note: The GSM antenna corresponds to the "M" of the handle

天线支架安装注意事项

Antenna support installation precautions



7.3、温度传感器安装注意事项 Temperature Sensor Installation Precautions

温度传感器：放置于电芯与电芯之间的沟槽里固定住，任何时候都不能挤压，防止损坏。

Temperature sensor: fixed in the groove between the battery cell and the battery cell, can not be squeezed at any time to prevent damage.

作用：实时监测电池的温度

Function: Real-time monitoring of battery temperature



温度传感器安装示意说明
Temperature sensor installation



特别注意：

- 1、温度传感器感应头部不能挤压。
- 2、所有线材过线都不能压线。
- 3、温控线的走线排布不要扯太紧，以免使用过程中拉扯松动；主板插头结合处要打胶固定。

Pay special attention to:

- 1, the temperature sensor sensor head can not be squeezed.
- 2, all wires can not be pressed over the line.
- 3, the layout of the temperature control line should not be pulled too tight, so as not to pull loose during use; The connector of the motherboard should be fixed with glue.

注意一定要加导热硅脂传热
Be sure to add thermal grease to heat transfer



■ 下表为软硅胶线导线线径选择参考：

The following table is a reference for selecting the diameter of the soft silicone wire conductor:

电流 Current	线号 Wire Gauge	截面积 Section Surface
80A	7AWG	12mm ²
100-120A	6AWG	16mm ²
200A	4AWG	25mm ²
250A	3AWG	35mm ²
300-400A	2AWG	50mm ²
500A	0AWG	75mm ²

※ 注意：一定要根据实际放电电流选择相对应的线材，线径不能偏小，否则放电过程中易造成保护板温度过高，从而影响保护板的使用性能。

※ Notice: Be sure to select the corresponding wire according to the actual discharge current, the wire diameter can not be small, otherwise the discharge process is easy to cause the temperature of the protection board is too high, thus affecting the performance of the protection board.



八、使用注意事项 Usage Precautions

- 安装保护板之前，电池一定要匹配好，每节电池电压相差低于0.05V，内阻相差低于5mΩ，容量相差低于30mAh。
Before installing the protection board, the battery must be matched, with the voltage difference of each battery less than 0.05V, the internal resistance difference less than 5mΩ, and the capacity difference less than 30mAh.
- 初次连接保护板，电池电压不要太高也不要太低，铁锂电池在2.8到3.4V之间，聚合物电池在3V到4V之间。电池电压太高会触发保护，导致保护板无法正常工作。如果电池已经充满，请放低至要求电压后再连接保护板。
For the first time to connect the protection board, the battery voltage should not be too high or too low. The voltage for LFP battery should be between 2.8 and 3.4V, and the voltage for polymer battery should be between 3V and 4V. If the battery voltage is too high, the protection board won't work properly. If the battery is fully charged, lower it to the required voltage before connecting the protection board.
- 保护板B0对应的那条排线为接线的第一条排线（线材为黑色，接B-），第2根线（线材为白色）连接第1串电池正极，后面依次连接每一串正极，直到最后一串B+（线材为红色，接B+）。**焊排线时排线切不可插在保护板上面去焊接。**接线一定要按照顺序去接，排线接错，可能会导致保护板烧坏和无法正常工作。
Protection board B0 corresponds to the first row of cables (where the cable is black and connects to B-), and the second cable (where the cable is white) connects to the first strings of positive battery terminals, and then connects to each strings of positive terminals at the lower order, until the last strings of B+ (where the cable is red and connects to B+). **Do not insert the wire into the protective board for welding.** Wiring must be connected in order, the wrong wiring may cause the protection board to burn out and not work normally.
- 排线接好后，插头不要直接插入，要测试插头背面每2个相邻金属端子间的电压，注意确认每串电池电压相差要低于0.05V。
After the cable is connected, the plug cannot insert directly. Make sure that the voltage difference of each battery string is less than 0.05V by testing the voltage between each two adjacent metal terminals on the back of the plug.
- 15串以上的保护板，在接好排线的情况下，请注意保护板的两个排线插头绝对不可以插反，插反会直接烧板；**排线是先插有B-黑色线材的低压排线，再插另一个有B+红色线材的高压排线。**
For more than 15 strings of protection boards, when the row of cables is connected, please note that the two row of cable plugs of the protection board must not be inserted in the opposite way. Otherwise, the protection board will be directly burned. **The cable is a low voltage cable with a B-black cable inserted first, and then another high voltage cable with a B+ red cable inserted.**
- 保护板接好线之后，**电池总电压与保护板输出电压相等**，才代表接线正确，此时才可以进行充放电使用。
After the protection board is connected, **ensure that the total battery voltage is the same as the output voltage of the protection board.** Only when the battery is connected correctly, can it be charged or discharged.
- 使用中注意引线头、电烙铁、锡渣等不要碰到电路板上的元器件，否则易损坏本保护板。
Pay attention to the lead, soldering iron, tin slag, etc. do not touch the components on the circuit board, otherwise it is easy to damage the protection board.



- 焊接电池引线时，一定不可有错接或反接。如果确认已接错，这块电路板可能已损坏，需要重新测试合格后才可使用
When welding battery leads, do not connect wrong or reverse connect them. If it is confirmed that it has been connected incorrectly, the circuit board may be damaged and needs to be re-tested before it can be used.
- 装配时保护板不要直接接触到电芯表面，以免损坏电芯。装配要牢固可靠。
During assembly, the protection board should not directly contact the surface of the battery cell to avoid damage to the battery cell. The assembly should be strong and reliable.
- 保护板和电池组组装作业时，勿将散热铝板靠近电芯表面，否则热量会传递给电芯，影响电池组安全。
When assembling the protection board and battery pack, do not place the heat-dissipating aluminum board near the surface of the battery cell; otherwise, heat will be transferred to the battery cell, which will affect the safety of the battery pack.
- 将电池组和保护板组合好以后，首次上电如发现无电压输出或充不进电，请检查接线是否正确。
After assembling the battery string and protection board, if no voltage is generated or no power is supplied during the first power-on, check whether cables are correctly connected.
- 在测试、安装、使用、接触该保护板时，需做好相应的防静电措施。
When you test, install, use, or touch the protection board, take appropriate ESD measures.
- 在对装好保护板的电池组进行充放电测试时，请不要使用电池老化柜对电池组各节电池电压进行测量，否则有可能损坏保护板和电池。
Do not use the battery aging cabinet to measure the voltage of each battery string when charging or discharging a battery string installed with a protection board. Otherwise, the protection board and batteries may be damaged.
- 本保护板没有0V充电功能，电池一旦出现0V的情况下，电池将严重退化直至损坏，为了不损坏电池，用户在长期（电池组容量大于2AH，储存超过3个月）不使用时请定期充电补充电量，在使用过程中放电保护后，须在12小时内及时充电，防止电池因自耗电而放电至0V。
This protection board does not have 0V charging function, once the battery appears 0V, the battery will be seriously degraded until damaged, in order not to damage the battery, users in the long-term (battery pack capacity is greater than 2AH, storage for more than 3 months) do not use, please charge regularly and replenish the power, in the use of discharge protection, must be timely charged within 12 hours. Prevent the battery from discharging to 0V due to self-consumption.
- 本保护板未配置反充电保护功能，使用时不可将充电输入反接，否则可能损坏保护板和电池。
The protection board is not equipped with the anti-charge protection function. Do not reverse connect the charging input when in use; otherwise, the protection board and battery may be damaged.
- 请使用符合本规格书规定的充电器，如使用高于充电口最高可承受的直流电压的充电器，易造成保护板损坏，充电器应优先选择具备充电电流末端涓流关闭功能的产品（双保险）。注意不具备涓流关闭功能的充电器是为铅酸电池设计的，不适合锂电池使用。
Please use the charger that meets the requirements of this specification. If the charger is higher than the maximum DC voltage of the charging port, it may cause damage to the protection board. The charger with the trickling off function at the end of the charging current should be preferred (double safety). Note that the charger that does not have the trickle off function is designed for lead-acid batteries and is not suitable for lithium batteries.



- 产品使用过程中一定要遵循设计参数及使用条件，不得超过本规格书中的值；如违反本规格书，易损坏保护板，进而损坏电池组。

During the use of the product must follow the design parameters and conditions of use, shall not exceed the values in this specification; If this specification is violated, it is easy to damage the protection board, and then damage the battery pack.

- 使用过程中如出现异常情况，请立即停止使用，送回原厂或请专业维修人员进行维修。

If there is any abnormal situation during use, please stop using immediately and return to the original factory or ask professional maintenance personnel for repair.

- 禁止将两个及两个以上的保护板串联或并联使用。

Two or more protection boards are prohibited from being connected in strings or in parallel.

- 本保护板已经做了大量的可靠性试验，可靠性远远高于市面上的一般保护板，但为尽可能的减少事故的发生，请使用合格的电芯。

A large number of reliability tests have been done on this protection board, which is much higher than the general protection board on the market, but in order to minimize the occurrence of accidents, please use qualified batteries.

- **电池组容量和保护板持续放电电流之间的关系：建议电池组容量多少安时，就选用持续放电电流为多少安的保护板。（例如：50AH的电池组要选择持续放电电流至少为50A的保护板）**

The relationship between the battery pack capacity and the continuous discharge current of the protection board:

It is recommended that the battery pack capacity is many amps, and the protection board with continuous discharge current is many amps is selected. (For example: 50AH battery pack to choose a continuous discharge current of at least 50A protection board)

注：长期超载工作，会损坏保护板，减少其使用寿命。

Note: Long-term overload will damage the protection board and reduce its service life.



九、主要元器件清单 Main Component List

序号 NO.	类型 Type	名称 Name
1	保护IC IC Protection	中颖SH367309 ZhongyingSH367309
2	充电MOS管 Charging MOS Tube	MDT10N023RH、BLP021N10
3	放电MOS管 Discharging MOS Tube	MDT10N023RH、BLP021N10

请客户注意：我司各型号保护板在批量出货过程中，不同批次的订单我司有可能更换不同品牌不同型号的 MOS 管，但是前提是在能满足上述性能指标的情况下而做出的更改。

Notice: In the batch shipment process of each model of our protection board, we may replace different brands of different models of MOS tubes for different batches of orders, but the premise is to make changes under the condition that the above performance indicators can be met.

十、产品修订记录表 Product Revision Record

版本 Revision	变更内容 Modified Content	责任人 Principle	日期 Date	标记 Mark	备注 Note
V01	设计 Design	Z.WJ	20240327		